

Ref. DOB.



1X



84X



56X

Les Casiers d'Antan

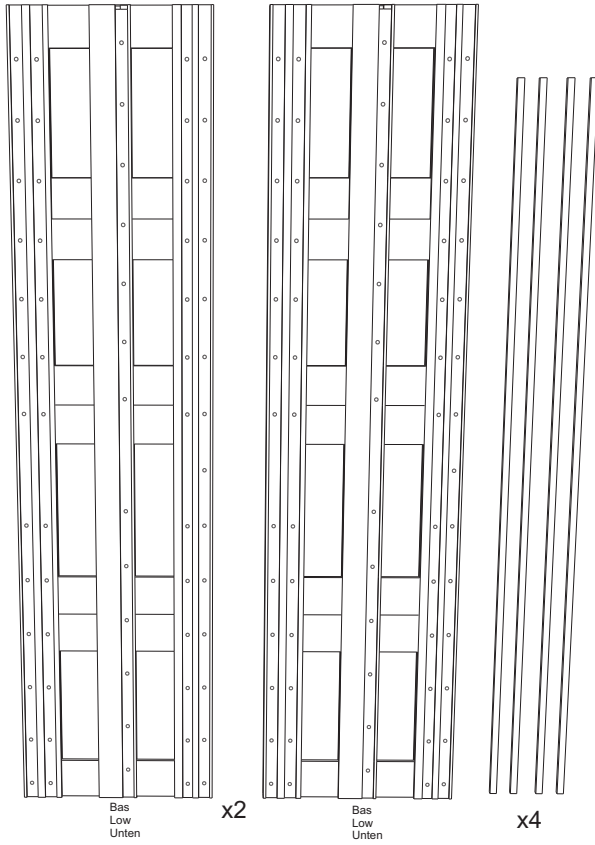

Ref. TDOB.

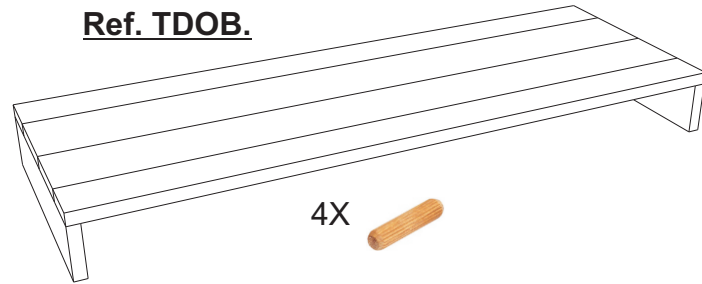

1

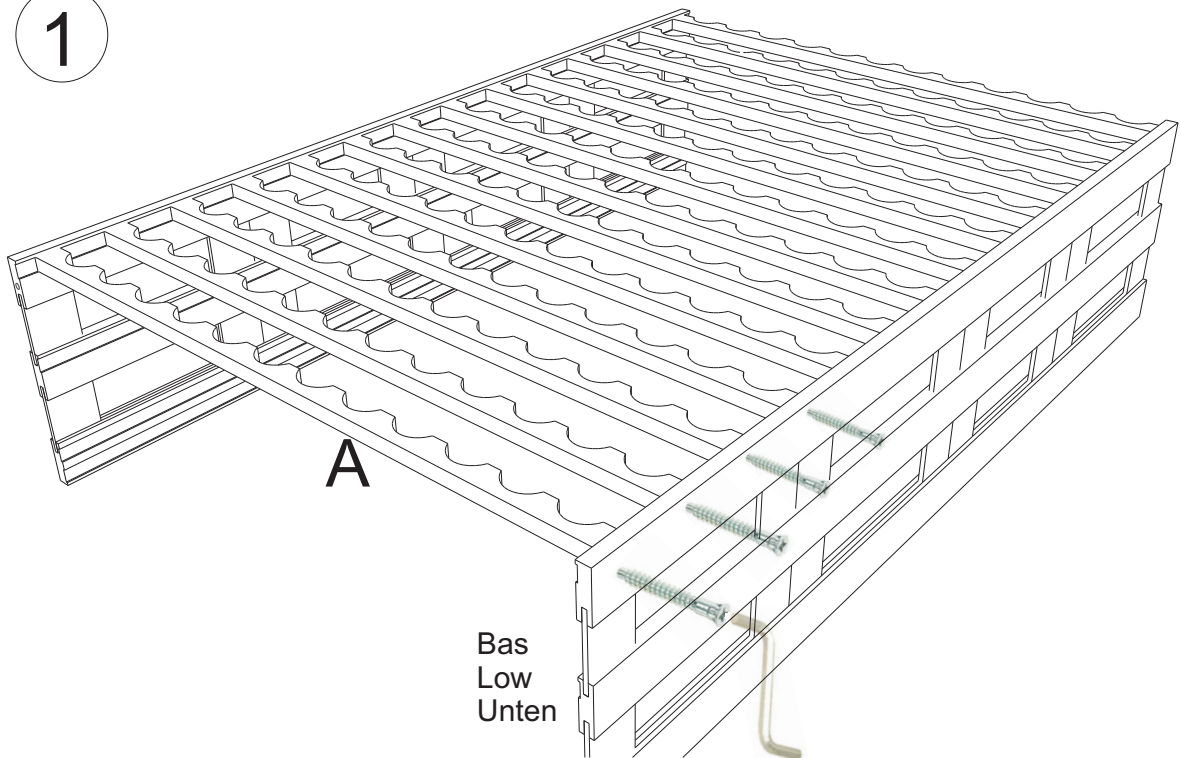

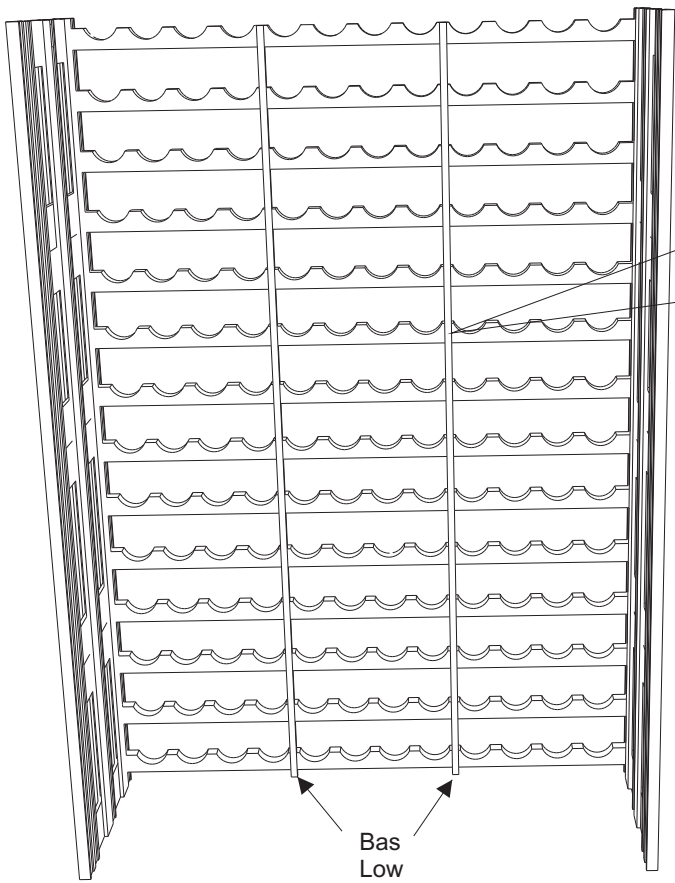

Bas
Low
Unten

2

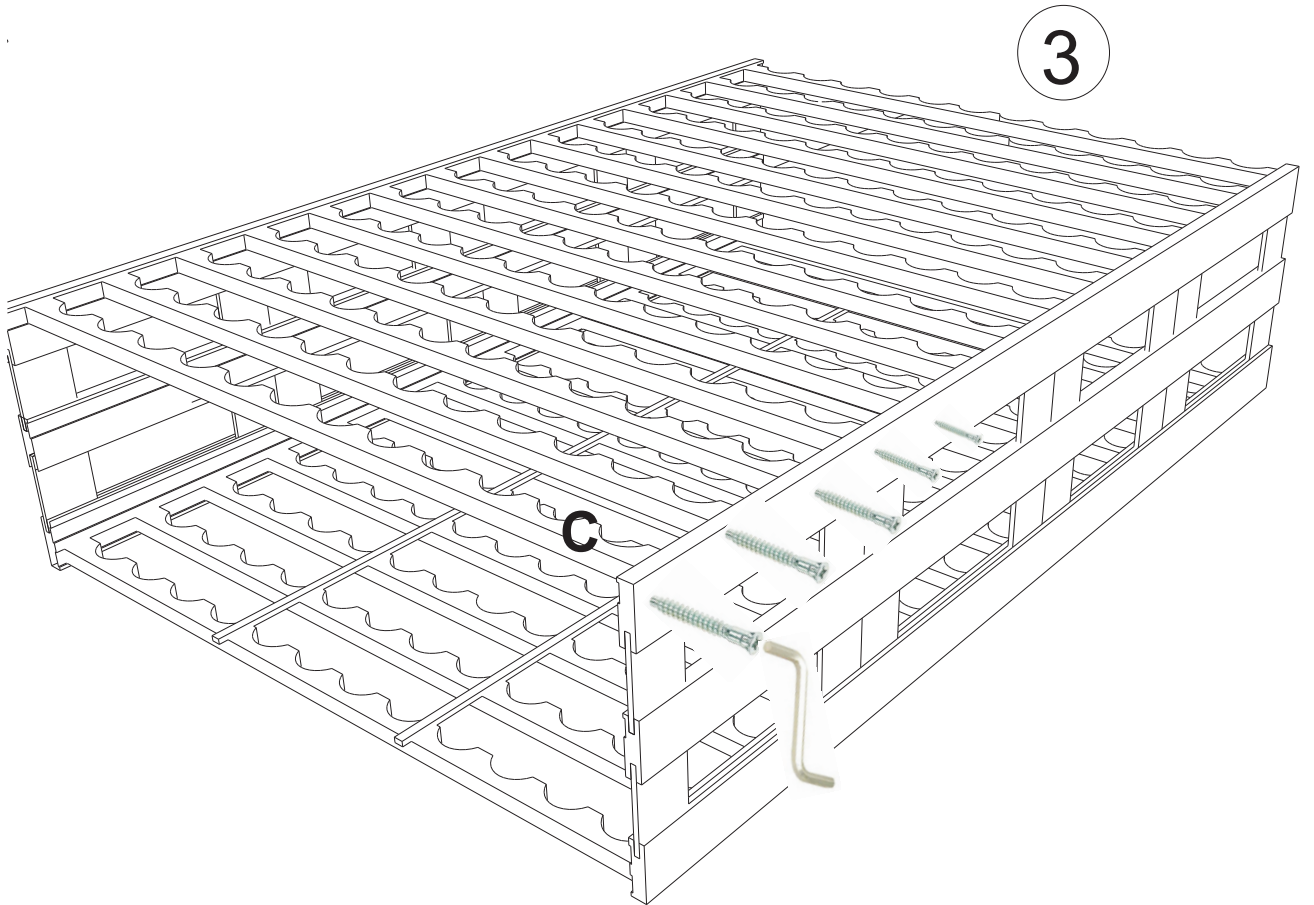
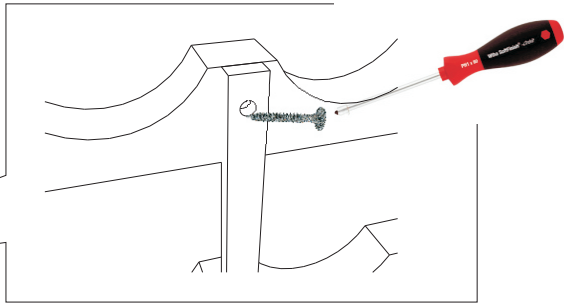

3

C

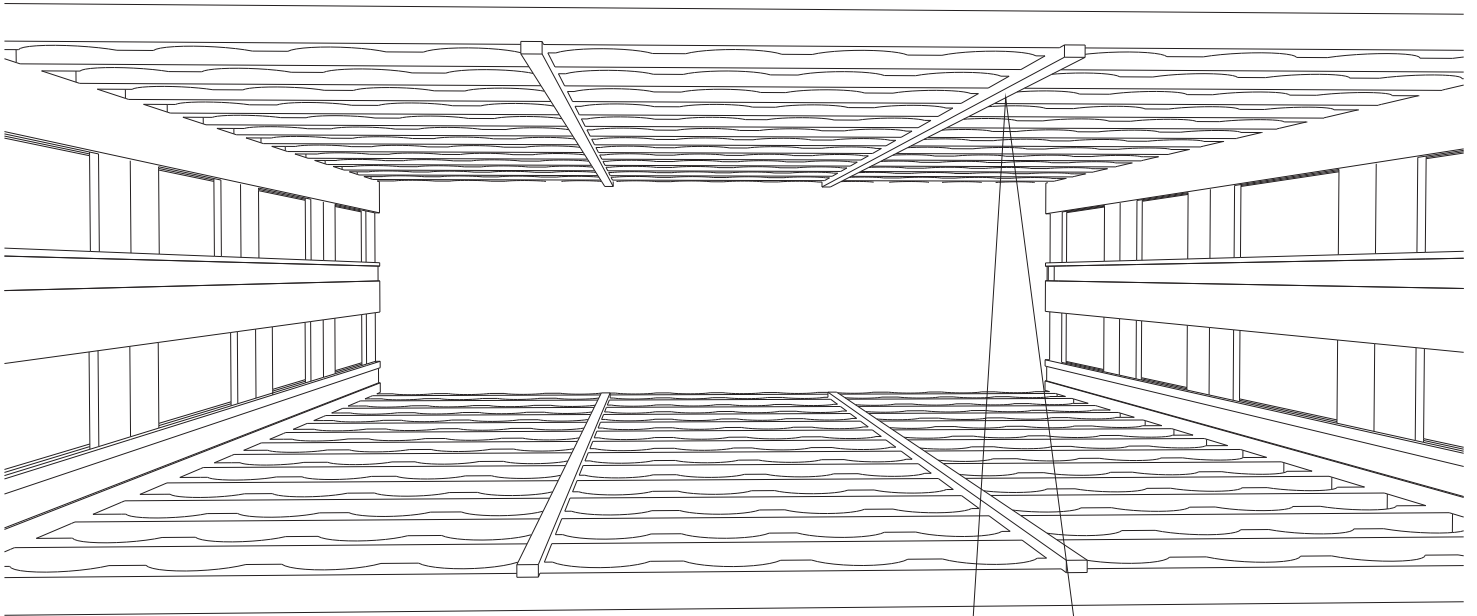

4

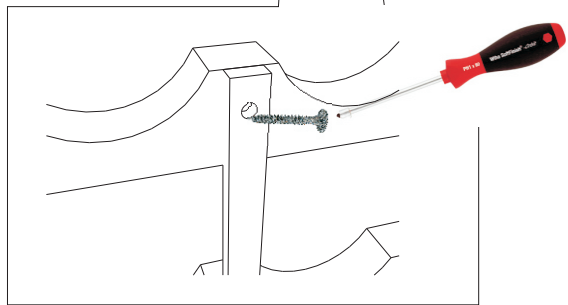

5

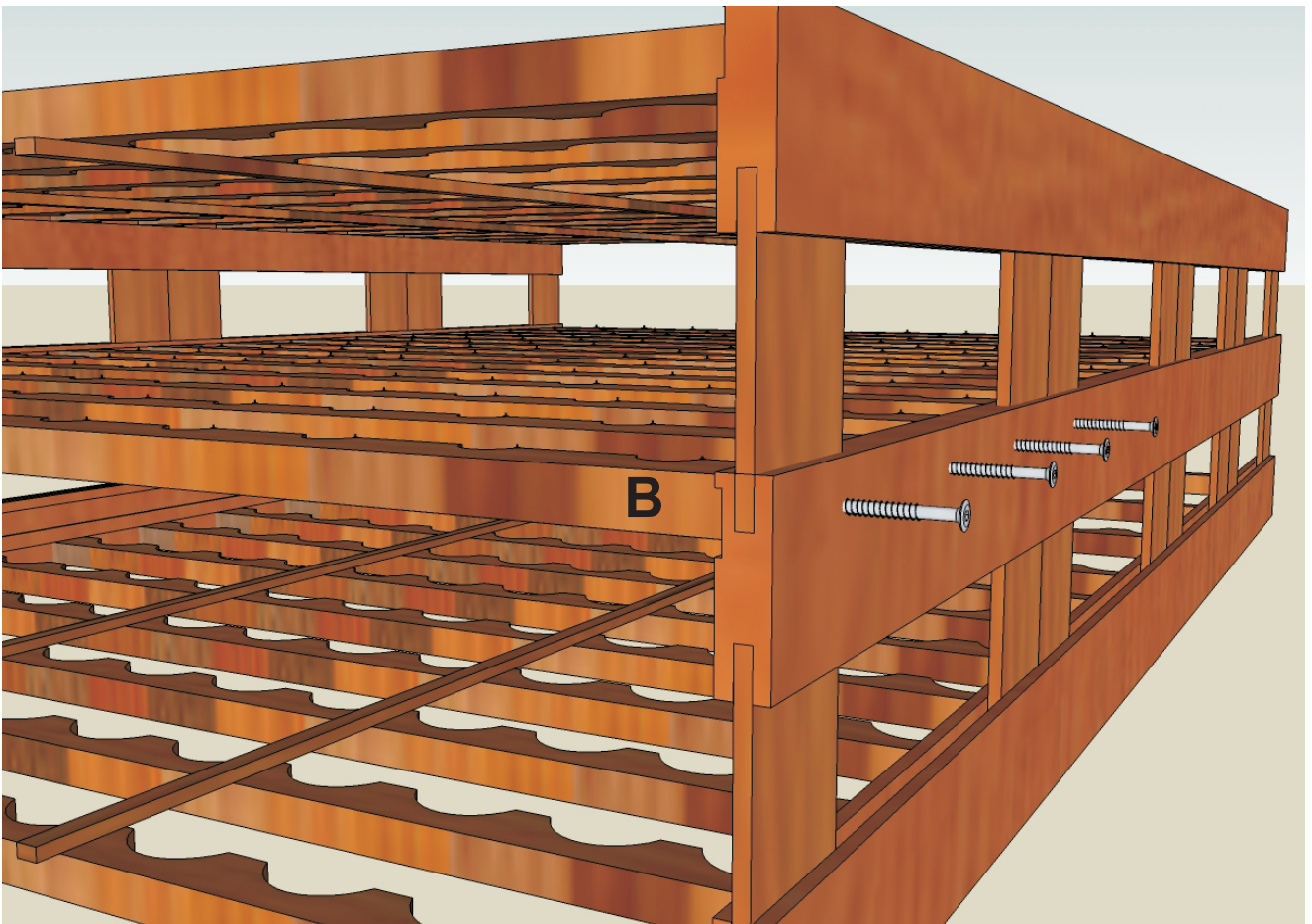

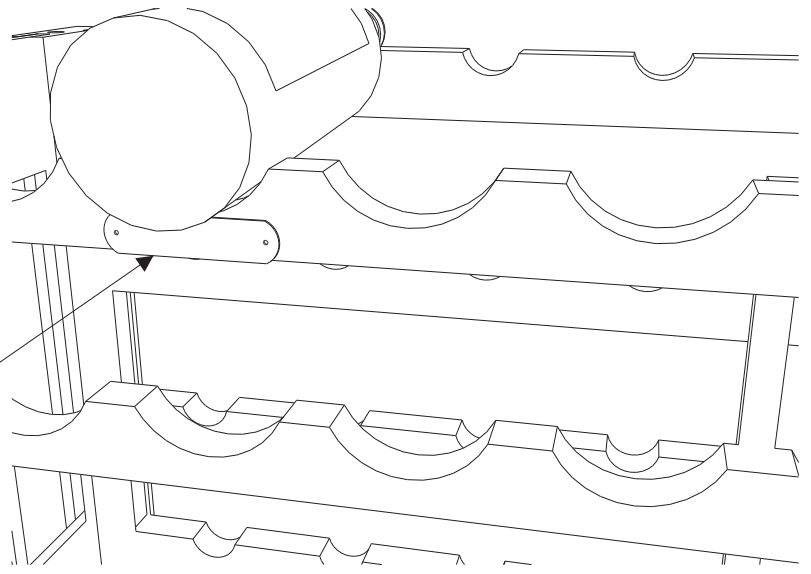

Ref. pe + pea + pei

Ref. TDOB

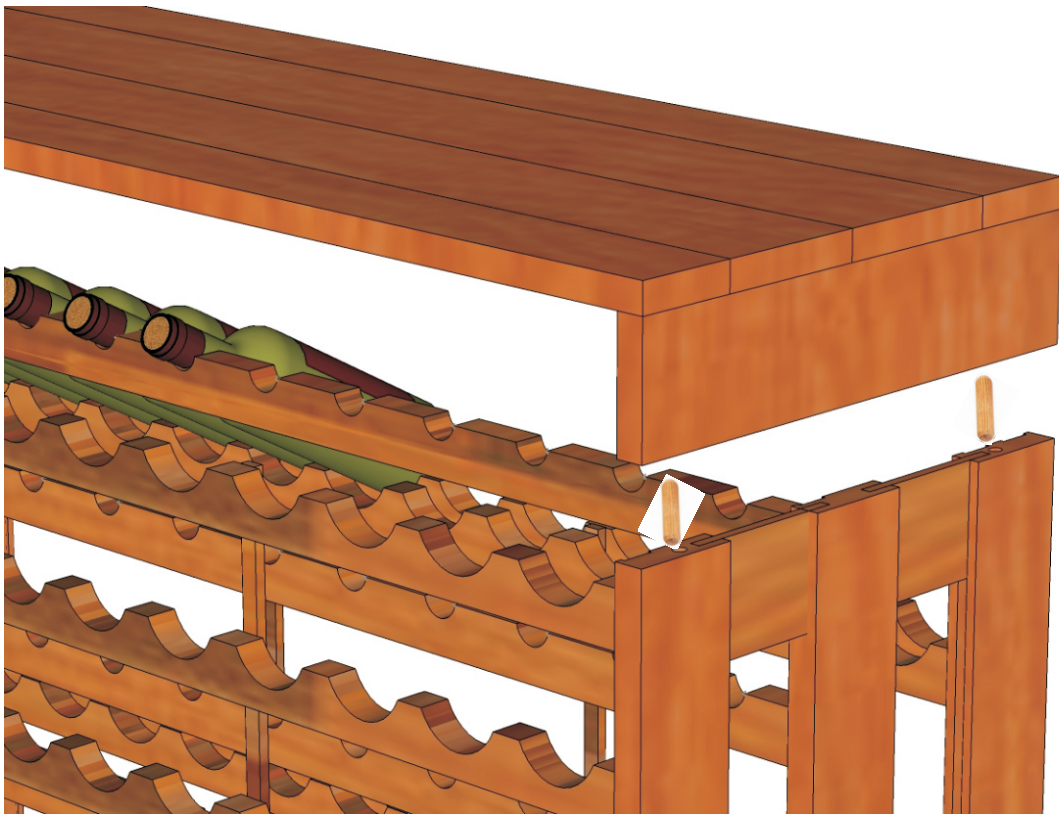

Méthode pour incliner les bouteilles / **Storage inclined at 45° method** /
 Die Flaschen werden mit einem Neigungswinkel von 45° präsentiert.

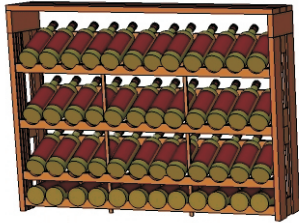

Ref. mb



Ref. opt

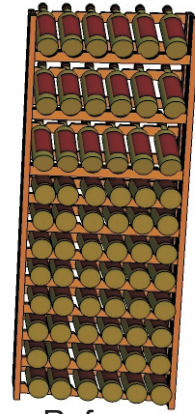

Ref. ma



Ref. DOB

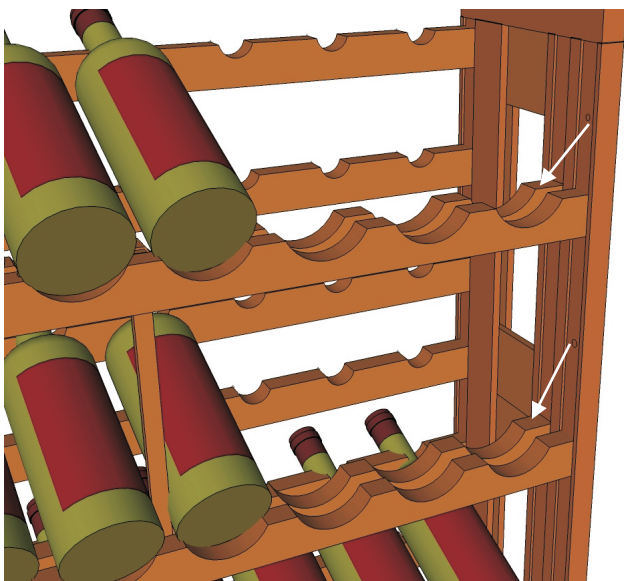

1

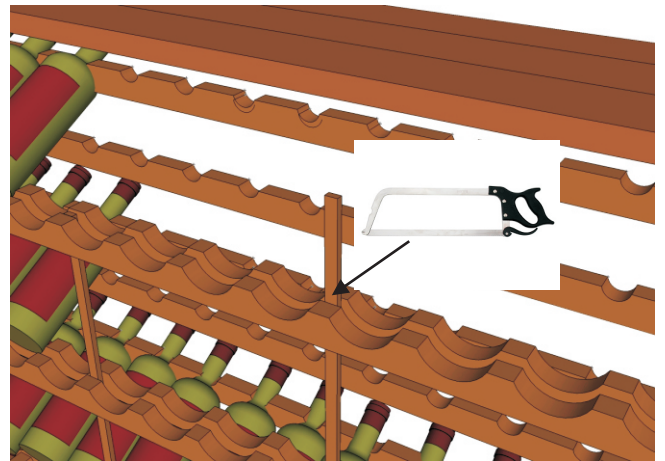

2

3

4

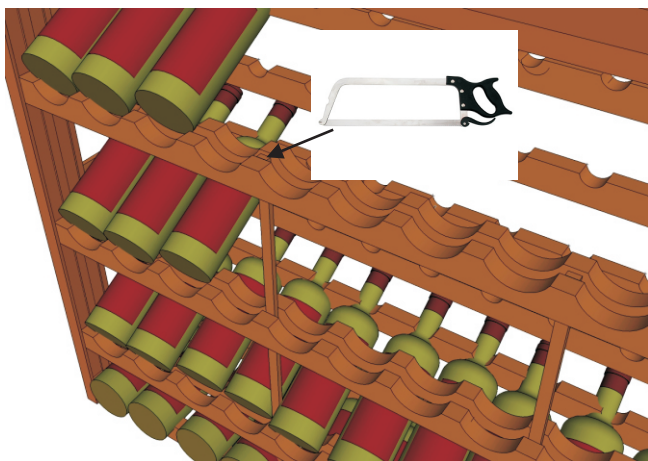

Uniquement pour Magnum
 Only for Magnum
 Nur für Magnum.

Magnums inclinés, retourner la barre.
 For inclined **Magnum**, turn the bar.
Magnum : Stab zurück.